



SmartCom3

INFRARED RADIANT INTERCONNECTING MANUAL

⚠ WARNING: Improper installation, adjustment, alteration, service or maintenance can cause property damage, injury or death. Read the installation, operating and maintenance instructions thoroughly before installing or servicing this equipment.

1 Single Zone Unitary Infrared Radiant Systems.

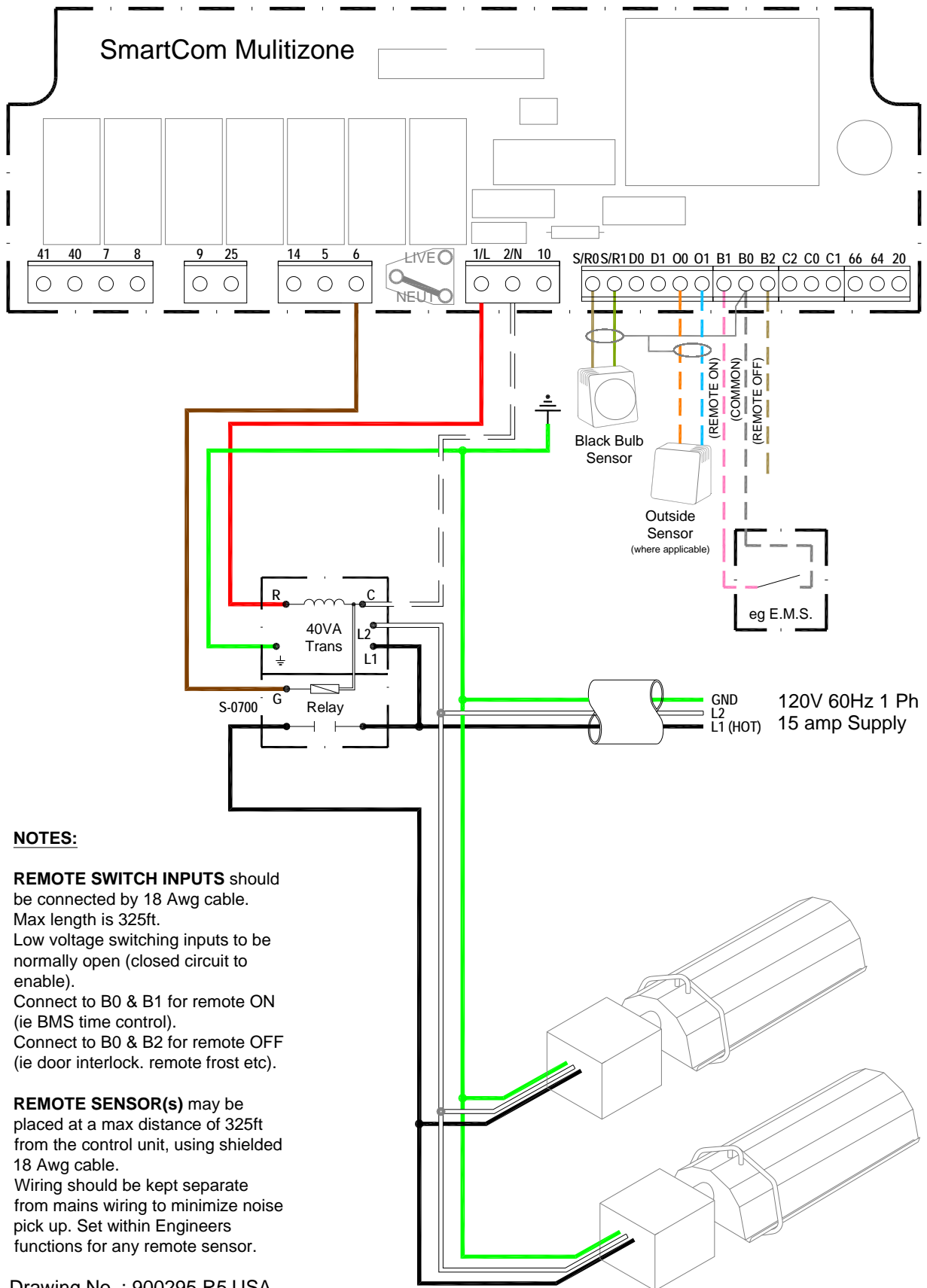

2 Single Zone Infrared Herringbone Fan Systems.

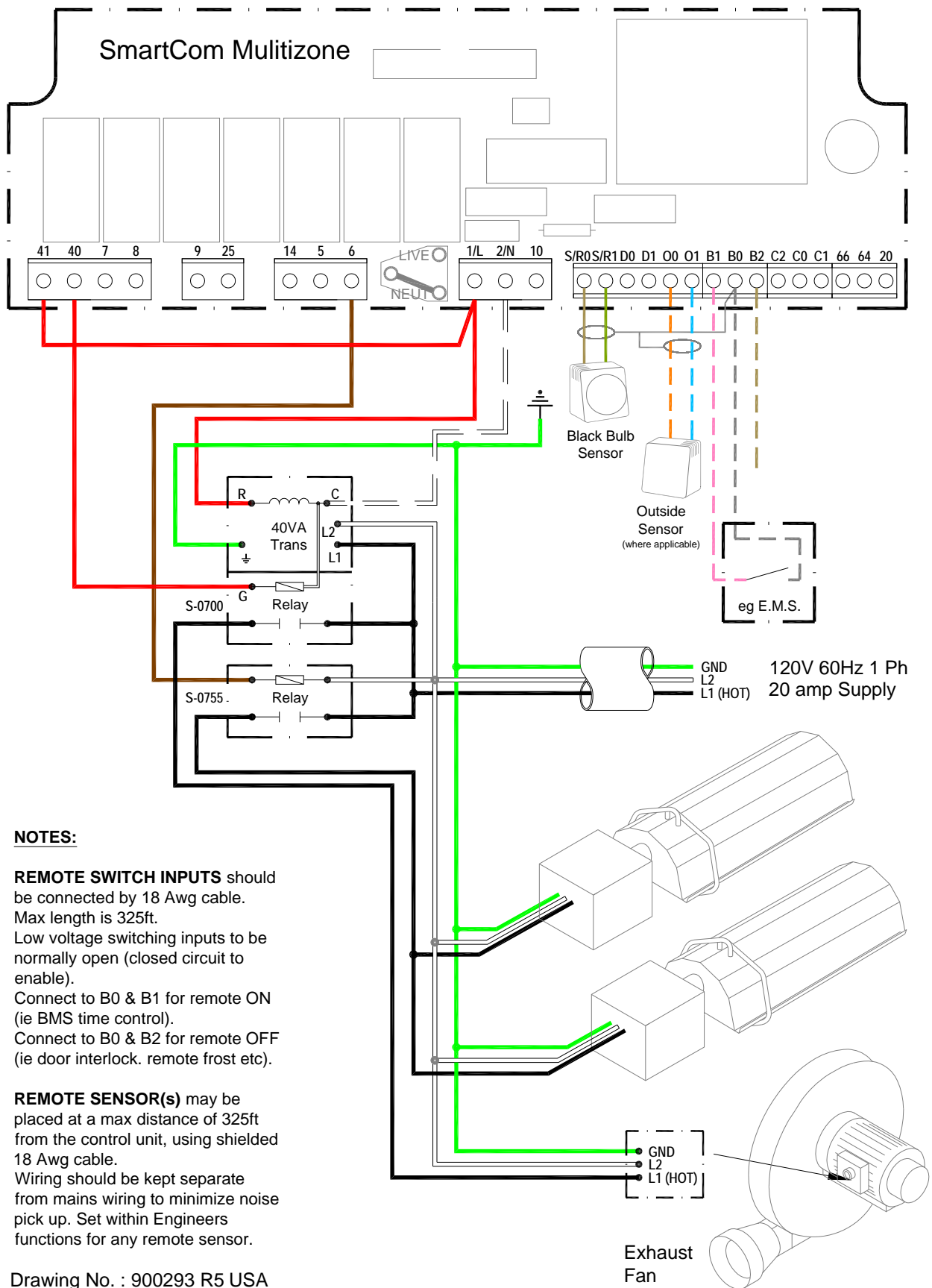

NOTES:

REMOTE SWITCH INPUTS should be connected by 18 Awg cable. Max length is 325ft. Low voltage switching inputs to be normally open (closed circuit to enable). Connect to B0 & B1 for remote ON (ie BMS time control). Connect to B0 & B2 for remote OFF (ie door interlock. remote frost etc).

REMOTE SENSOR(s) may be placed at a max distance of 325ft from the control unit, using shielded 18 Awg cable. Wiring should be kept separate from mains wiring to minimize noise pick up. Set within Engineers functions for any remote sensor.

Drawing No. : 900293 R5 USA

3 Multizone Unitary Infrared Radiant Systems.

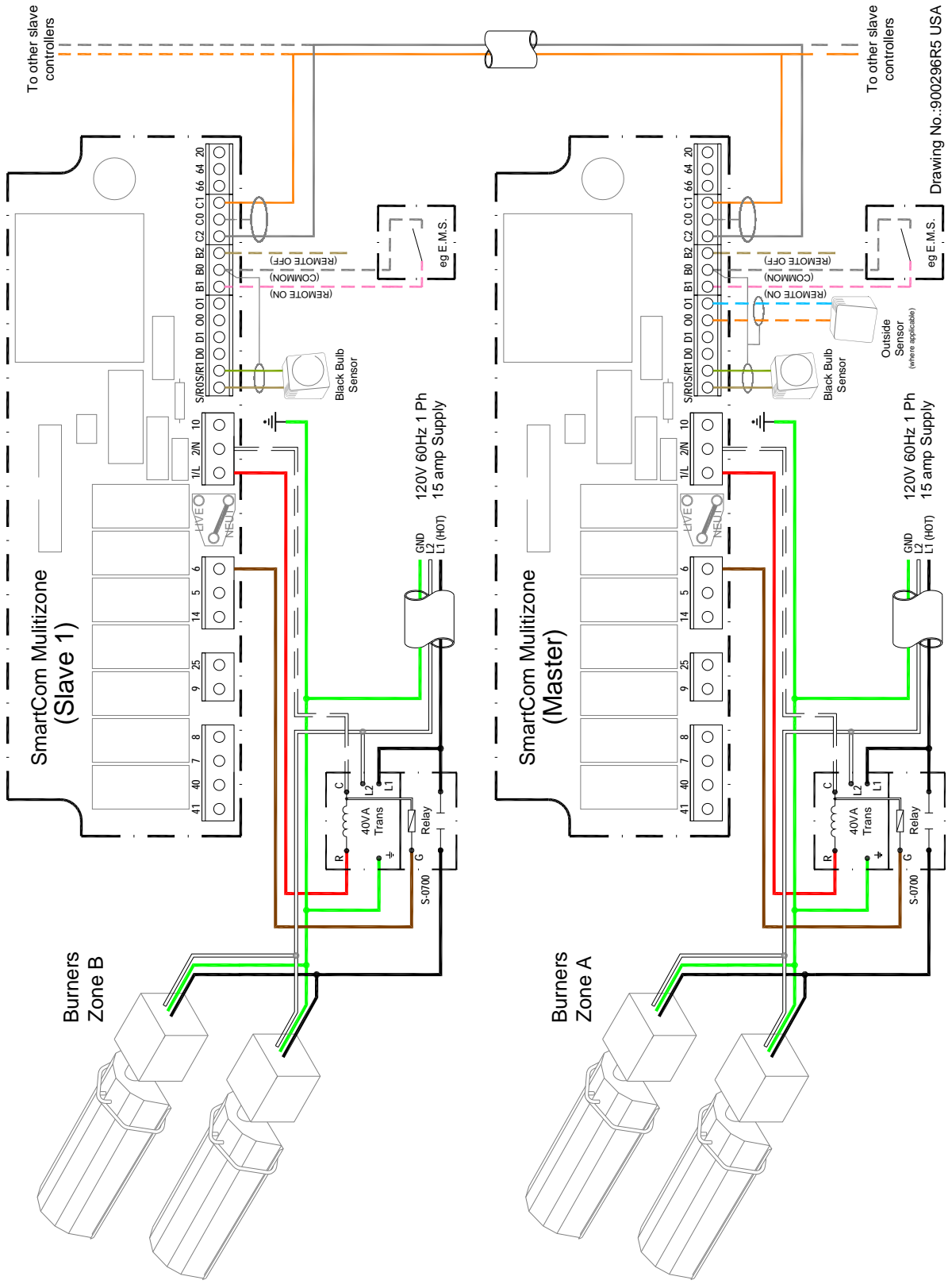

NOTES:

NETWORK. Master-slave (Network) communication is by shielded twisted pair cable, RS485 compatible such as Belden 9841. Maximum overall system length of 1650ft. Connect screen to C0.
NOTE: Diagram shows a master and ONE slave configuration. Wire further slaves in parallel.
REMOTE SWITCH INPUTS should be connected by 18 Awg cable. Max length is 325ft. Low voltage switching inputs to be normally open (closed circuit to enable). Connect to B0 & B1 for remote ON (ie BMS time control). Connect to B0 & B2 for remote OFF (ie door interlock, remote frost etc). For Master/Slave networks, remote OFF can be set for individual zones or total system via the Master. *If individual BMS ON/OFF on master/slaves systems are required, set all SmartCom programs to 24 hour and use normally closed contacts across B0 and B2. Set engineers variable.*

REMOTE SENSOR(s) may be placed at a max distance of 325ft from the control unit, using shielded 18 Awg cable. Wiring should be kept separate from mains wiring to minimize noise pick up. Set within Engineers functions for any remote sensors.

4 Split Zone Infrared Herringbone Fan Systems.

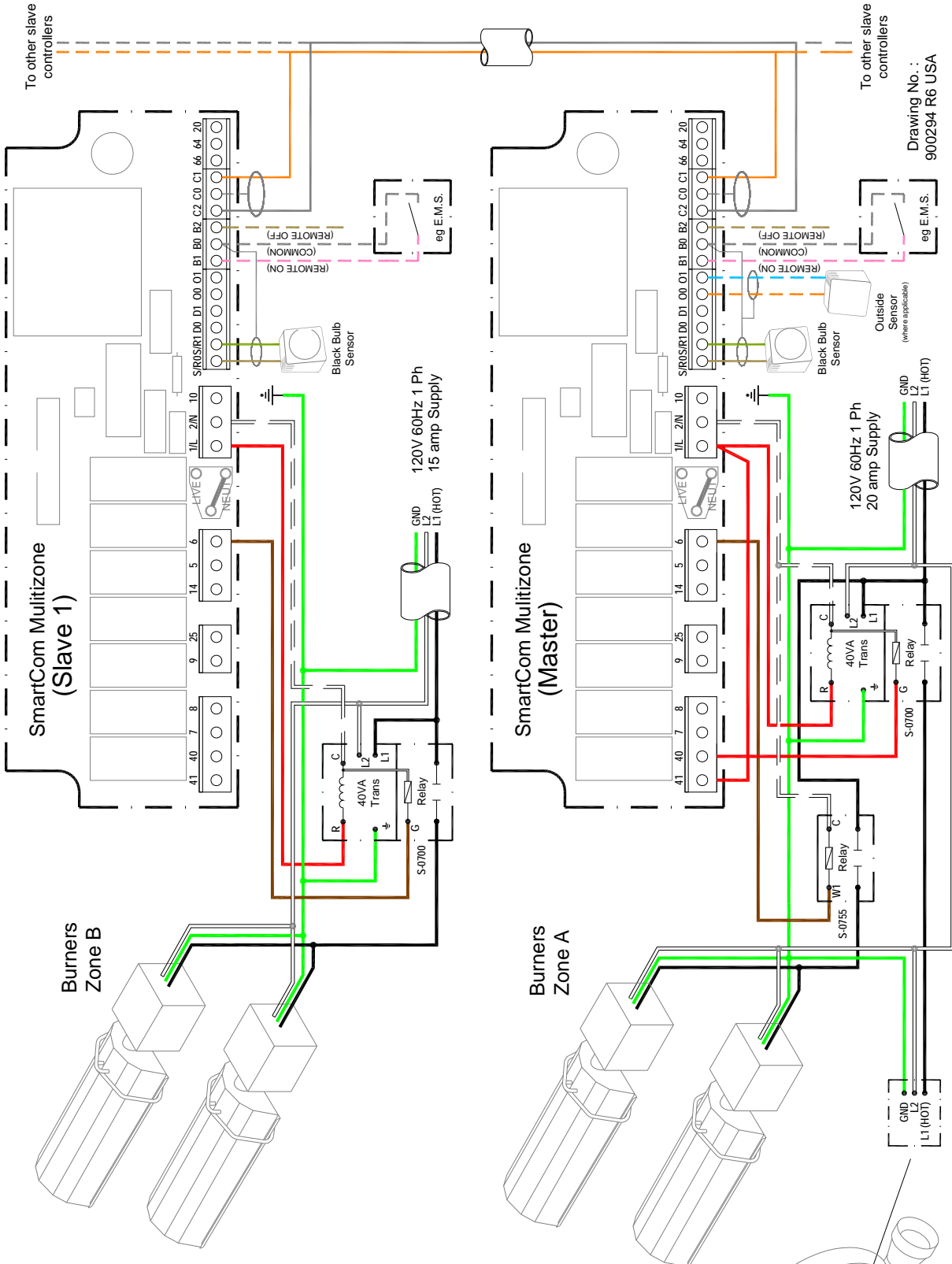

To other slave controllers

To other slave controllers

120V 60Hz 1 Ph
15 amp Supply

120V 60Hz 1 Ph
20 amp Supply

GND
L1 (HOT)

GND
L1 (HOT)

GND
L1 (HOT)

Exhaust Fan

Drawing No. :
900294 R6 USA

NOTES:

NETWORK. Master-slave (Network) communication is by shielded twisted pair cable, RS485 compatible such as Belden 9841. Maximum overall system length of 1650ft. Connect screen to CO.
NOTE: Diagram shows a master and ONE slave configuration**. Wire further slaves in parallel.

REMOTE SWITCH INPUTS should be connected by 18 Awg cable. Max length is 325ft. Low voltage switching inputs to be normally open (closed circuit to enable). Connect to B0 & B1 for remote ON (ie BMS time control). Connect to B0 & B2 for remote OFF (ie door interlock, remote frost etc). For Master/Slave networks, remote OFF can be set for individual zones or total system via the Master.
If individual BMS ON/OFF on master/slaves systems are required, set all SmartCom programs to 24 hour and use normally closed contacts across B0 and B2. Set engineers variable.

REMOTE SENSOR(s) may be placed at a max distance of 325ft from the control unit, using shielded 18 Awg cable. Wiring should be kept separate from mains wiring to minimize noise pick up. Set within Engineers functions for any remote sensors.

5 Multizone Infrared Herringbone Fan Systems.

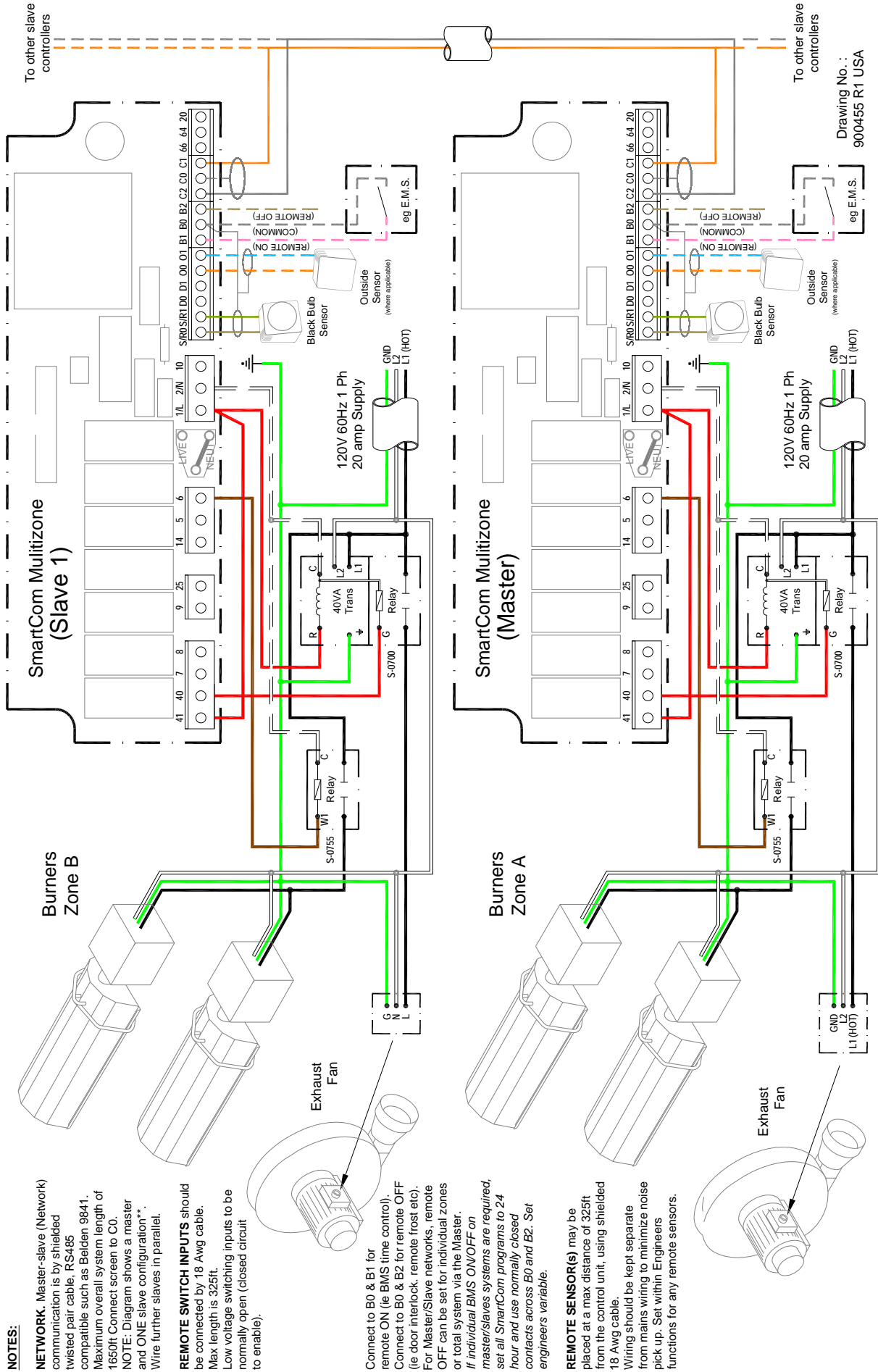

6 Schematic - 2 Zone, 1 Fan Herringbone System.

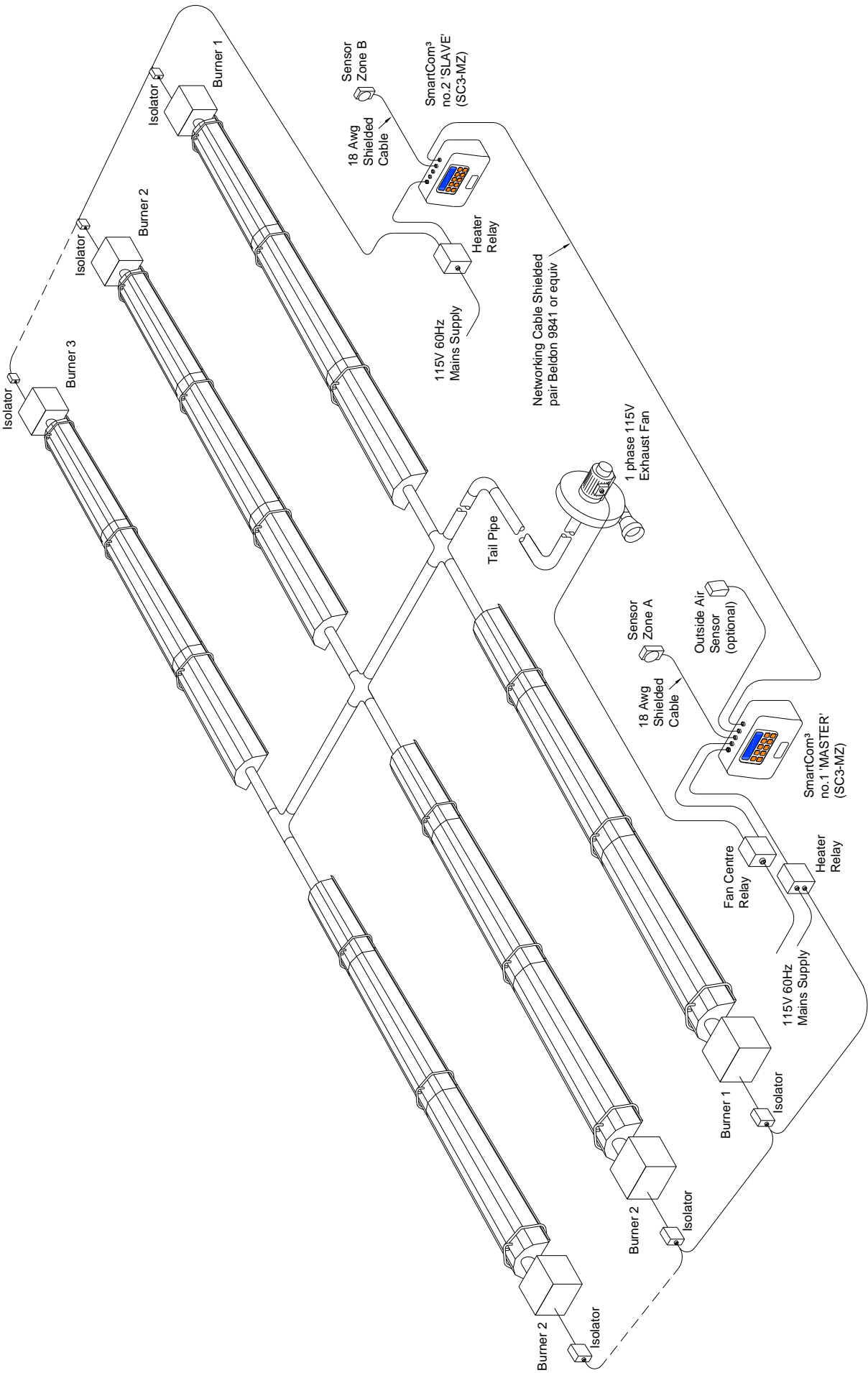

7 SmartCom³ Radiant Commissioning.



For ease and swiftness of initial start-up, the SmartCom³ range of electronic controllers is supplied factory pre-set to default settings as described in the SmartCom³ Installation and User Manual ref US/SCOM/29.

































The controllers will therefore operate immediately with standard **Infrared Radiant**

heaters without the need for on-site programming.

However, if either multi-zone Infrared, single or multi-zone Herringbone or single or multi-zone ARC systems are to be operated along with a Black Bulb Sensor, then the engineers' settings will have to be modified.

In order to access the engineer functions:

Press and hold in the  button and at the same time, press the  button.

		CONTROL TYPE RADIANT SET/OK	press		to advance
		ARC HEATERS OFF SET/OK	press		to advance
		RAD/ARC/HB SPLIT OFF SET/OK	press		to alter or press
press		once for split zonal systems			to advance
		RAD/ARC/HB SPLIT ON SET/OK	press		to accept. Press
		INTERNAL SENSOR ON SET/OK	press		to alter or press
press					to advance
		INTERNAL SENSOR OFF SET/OK	press		to accept. Press
press		once to turn off internal			to advance
		EXTERNAL SENSOR OFF SET/OK	press		to alter or press
		EXTERNAL SENSOR ON SET/OK	press		to accept. Press
press		once to turn on external			to advance
		NETWORKING OFF SET/OK	press		to alter or press
		NETWORKING ON SET/OK	press		to accept. Press
press		once for master slave			to advance
		MASTER UNIT OFF SET/OK	press		to alter or press
		MASTER UNIT ON SET/OK	press		to accept. Press
press		once if master unit			to advance
		SLAVE UNIT 0 SET/OK	press		to alter or press
		SLAVE UNIT 3 SET/OK	press		to accept. Press
press		for unique slave number			to advance
		SLAVE TOTAL 0 SET/OK	press		to alter or press
		SLAVE TOTAL 6 SET/OK	press		to accept. Press
press		for total no. of slaves			to advance

Notes:

MASTER & SLAVE (NETWORK)

When setting up a SmartCom³ Master and Slave (Network) system, the master controller will display an error message during commissioning. This will clear once the commissioning is complete.



REMOTE SWITCHED INPUTS

SmartCom³ controllers can be operated remotely via a remote ON or a remote OFF signal in the following ways:

A. Building Management System Control (BMS).



SmartCom³ controllers can be operated via a BMS system, by applying a volt free connection (ie closed circuit to enable) across terminals B1 and B0 turns the system on. Making this connection on a master controller will turn the entire system on whereas making this connection on a slave unit will only bring on that zone.

1. BMS Controlling Time only.

Ensure all the programmed ON times in the SmartCom³ are turned off (i.e. They read "- :- -").

2. BMS Controlling Time and Temperature.

Ensure all the programmed ON times in the SmartCom² are turned off (i.e. They read "- :- -"). Set all the required day temperatures to 30°C.

B. Remote Door Interlock



SmartCom³ controllers can be connect to a door interlock, remote frost stat or permanent off switch via terminals B2 and B0. When a volt free connection is provided (ie closed circuit to enable) at these terminals, the controller reverts to a FROST ONLY mode.

Refer to the individual wiring diagrams for wiring configurations and type.



Ambi-Rad Limited P.O. Box 617
Fishers, Indiana 46038
Telephone 317-577-0337
Facsimile 317-842-3989
Website www.ambirad.com/us

For the Distributor Nearest please
call **1-888-330-4878**

Your Local Representative

 An AmbiRad Group brand



AmbiRad is a registered trademark of AmbiRad Limited. Because of continuous product innovation, AmbiRad reserves the right to change product specification without due notice.